



BARWALT®

A MARSHALLTOWN® BRAND

14" (355.6 mm) TILE CUTTER

Part# TC14 | EDI# 33176



104 S. 8th Ave. | Marshalltown, IA
Phone 800-888-0127 / 641-753-0127 | Fax 800-477-6341 / 641-753-6341
www.MARSHALLTOWN.com
WS4089

INTRODUCTION

Thank you for purchasing the Barwalt 14" (355.6 mm) Tile Cutter. This innovative Tile Cutter allows you to make quick, clean, score-and-snap cuts.

Other features of your Tile Cutter include:

- Two rod sliding system with smooth operation
- Handle with comfortable grip
- $\frac{3}{8}$ " (9 mm) cut thickness
- Diagonal cutting on tiles up to $9\frac{7}{8}$ " x $9\frac{7}{8}$ " (251 x 251 mm)

This Tile Cutter can cut tile up to $\frac{3}{8}$ " (9 mm) thick and 14" (355.6 mm) long, including:

- Ceramic Tile
- Glass Tile
- Mosaic Tile*

**Does not cut flexible backing to mosaic tile products*

This owner's manual provides the information needed to operate and maintain this Tile Cutter. Carefully read and follow all safety and operating instructions in this manual. Ensure every operator of this Tile Cutter reads this manual before operating the unit. The replacement of any part on this Tile Cutter by other than the manufacturer's authorized replacement part may adversely affect the performance, durability, or safety of the product.

Be sure safety precautions are observed. Read and follow all safety and operating instructions in this operator's manual. The manufacturer reserves the right to make changes on or add improvements to its product at any time without prior notice or obligation. The manufacturer reserves the right to decide, upon its sole discretion and at any time, to discontinue this product.

This manual covers the Barwalt 14" (355.6 mm) Tile Cutter. For technical questions or repair parts, please call MARSHALLTOWN customer service at 1-800-888-0127 or visit www.MARSHALLTOWN.com.

ASSEMBLY

Your Tile Cutter comes partially assembled and may or may not require the following assembly steps before it is ready for use.

1. Loosen the knob and attach the ruler into groove of the graduation ruler.
2. Tighten in place with the knob.

TABLE OF CONTENTS

Introduction.....	2
Assembly	2
Safety Precautions.....	3
Warranty.....	4
Product Operation	5
Maintenance.....	7
Replacement Parts	7

SAFETY PRECAUTIONS



• DANGER or WARNING safety signs are located near specific hazards.

• General precautions are listed on CAUTION safety signs.

- This notation appears before warnings in the text. It means that the step that follows must be carried out to avoid the possibility of personal injury or death. These warnings are intended to help the technician avoid any potential hazards encountered in the normal service procedures. We strongly recommend that the reader takes advantage of the information provided to prevent personal injury or injury to others.

THE FOLLOWING PRECAUTIONS ARE SUGGESTED TO HELP PREVENT ACCIDENTS. A CAREFUL OPERATOR IS THE BEST OPERATOR. MOST ACCIDENTS CAN BE AVOIDED BY OBSERVING CERTAIN PRECAUTIONS. READ AND TAKE THE FOLLOWING PRECAUTIONS BEFORE OPERATING THIS EQUIPMENT TO HELP PREVENT ACCIDENTS. EQUIPMENT SHOULD BE OPERATED ONLY BY THOSE WHO ARE RESPONSIBLE AND INSTRUCTED TO DO SO.



CALIFORNIA PROPOSITION 65 WARNING: This product can expose you to chemicals known to the State of California to cause cancer, birth defects, or other reproductive harm.

- Read all operating and maintenance instructions before operating or servicing the tile cutter.
- A tile cutter is only as safe as its operator. Give complete and undivided attention to the operation of the tile cutter.
- Know how to stop the tile cutter instantly.



NEVER operate the tile cutter if any components have been removed.

- Keep inexperienced and unauthorized people away from the tile cutter at all times.
- Keep the tile cutter in good operational condition. Loose or damaged parts are dangerous.
- Avoid loose clothing that could get caught in moving parts.



Keep hands and feet away from moving parts.

- Clear the work area around the cutter to prevent tripping or falling onto the cutter.
- Operate on level ground to prevent the tile cutter from flipping over.
- **DO NOT OPERATE** this tile cutter under the influence of alcohol or while taking medication that impairs your reactions.
- Use only factory authorized parts for replacement.
- Wear safety glasses when operating the tile cutter.
- Always use caution when replacing the cutting wheel.
- Only operate the cutter with the approved materials. If extreme force is required to cut a material, it may result in personal injury and/or damage to the tile cutter.
- Wear proper protective clothing while operating tile cutter, including eye, ear, and clothing.
- Handle all solvents and cleaning agents with care and follow manufacturer's instructions on safety and disposal.

WARRANTY

This product is warranted to the original purchaser only, to be free of defects in material and workmanship under normal use, for one year from purchase date. MARSHALLTOWN shall without charge for parts and labor, repair or replace such parts which are found to be defective. All transportation charges for replacement parts must be borne by the purchaser.

For warranty service, the product must be delivered, with proof of purchase date, to MARSHALLTOWN. Contact MARSHALLTOWN Customer Service to determine the best method of delivering the product that is under warranty. The delivery of the product must be made no later than 30 days after the expiration of the warranty period.

All implied warranties, including those of merchantability and fitness for a particular purpose, are limited to one year from date of purchase by the original retail customer and to the extent permitted by law any and all implied warranties are excluded and disclaimed after the expiration of such period.

Some states do not allow limitations on how long an implied warranty lasts, or the exclusion or limitations of incidental or consequential damages, so the above limitations or exclusions may not apply to you. This warranty gives you specific legal rights, and you may also have other rights, which vary from state to state.

Exclusion from this warranty:

1. All consequential damages, including pickup and delivery of the unit, communication, mileage charges and/or rental of a replacement unit during repairs are not covered under this warranty, or are any loss of income and/or other loss resulting from the failure of the product to function due to a warranty defect.
2. This warranty will not apply when the product becomes inoperative due to misuse, normal wear, neglect, improper maintenance, accident or freight damage; has not been operated and maintained in accordance with the instructions furnished in the Operator's Manual; or has been altered or modified without approval from the factory Service Department.
3. No parts or products are to be returned to the factory without prior written approval from the factory.

PRODUCT OPERATION

- Be sure to place the cutter on a flat and even surface when in use.
- Do not exert too much force on the cutter or tiles as this will cause tiles to break.
- After you cut tiles, be alert that the newly cut edge can be sharp.

To cut a straight line:

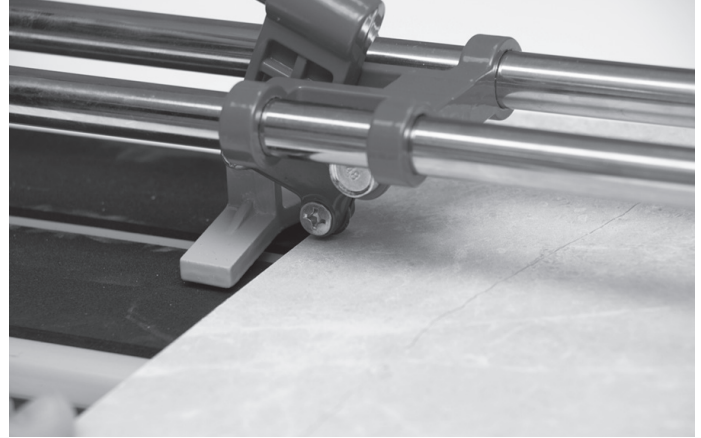
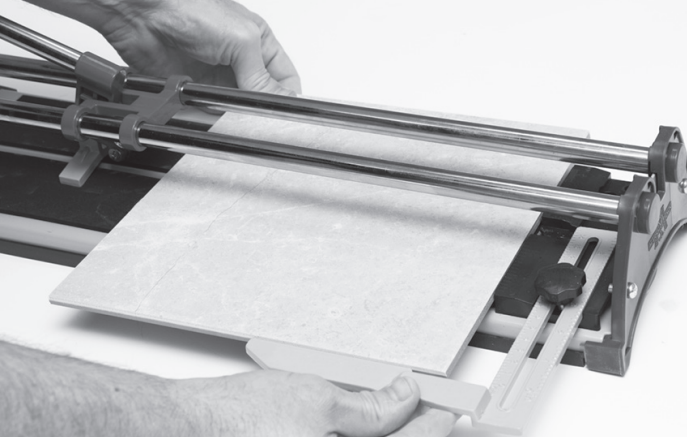

1. Place tile on base and slide until flush against the guide. Adjust the square guide to desired position.

2. Place the cutting wheel on the rear edge of the tile and slide the wheel forward by pushing the handle down, scoring the tile as the handle is pushed forward. It is important to make this scoring cut in one continuous motion, scoring only once per tile.

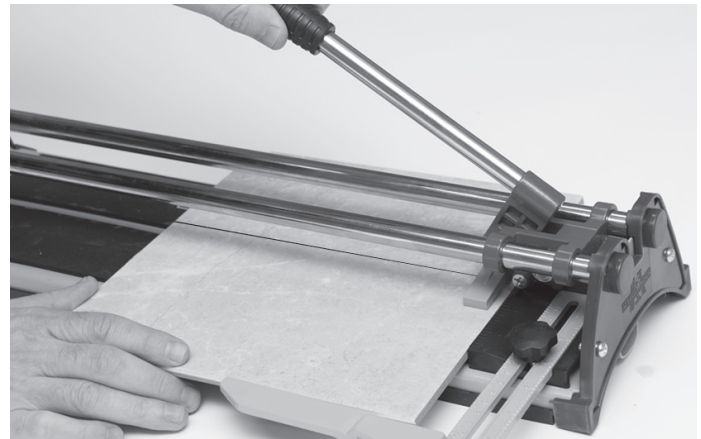
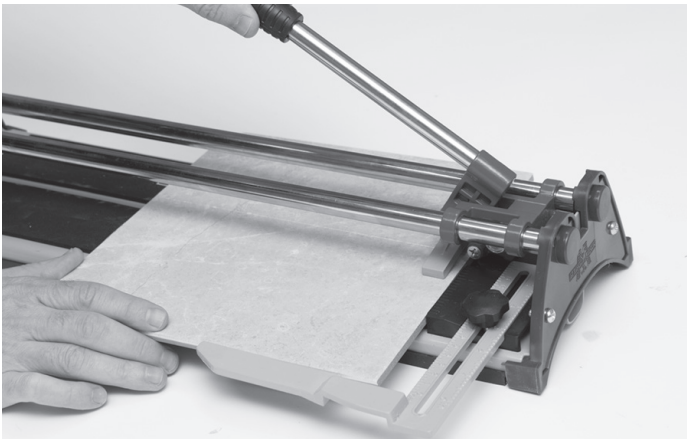

3. After scoring, and without moving the tile, position the handle so that the breaker foot is directly above the tiles front edge (at the stop).

4. Apply increasing downward pressure on handle until the tile snaps.

To cut an angle:

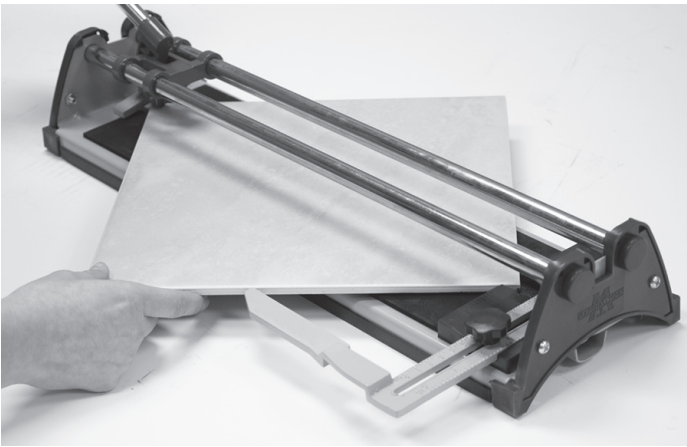

1. Place tile at desired angle and place the guide against the tile.

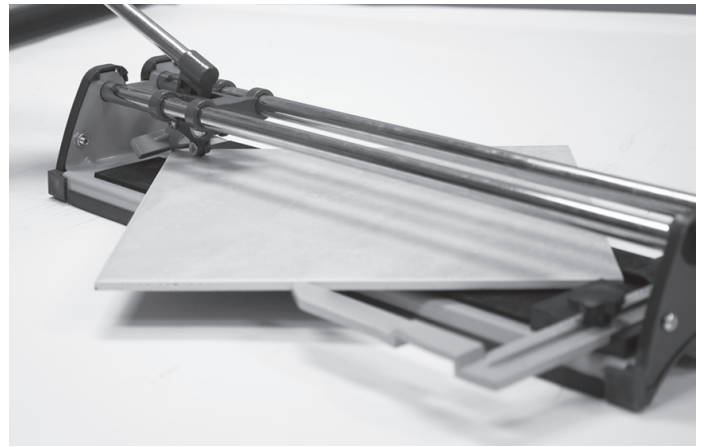

2. Carefully lower wheel until it makes contact with tile and then apply consistent pressure while scoring full length of the tile.



3. Flip the breaker down and position slightly away from the front edge of the tile.

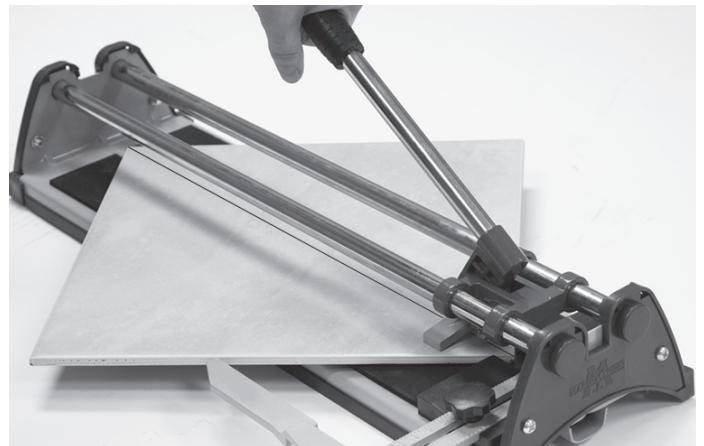

4. Apply increasing downward pressure on handle until the tile snaps.

CUTTING WHEEL REPLACEMENT

Carefully loosen and remove cutting wheel machine screw. Take caution as the cutting wheel could fall when the bolt is removed. Insert new cutting wheel into opening and replace machine screw then tighten.

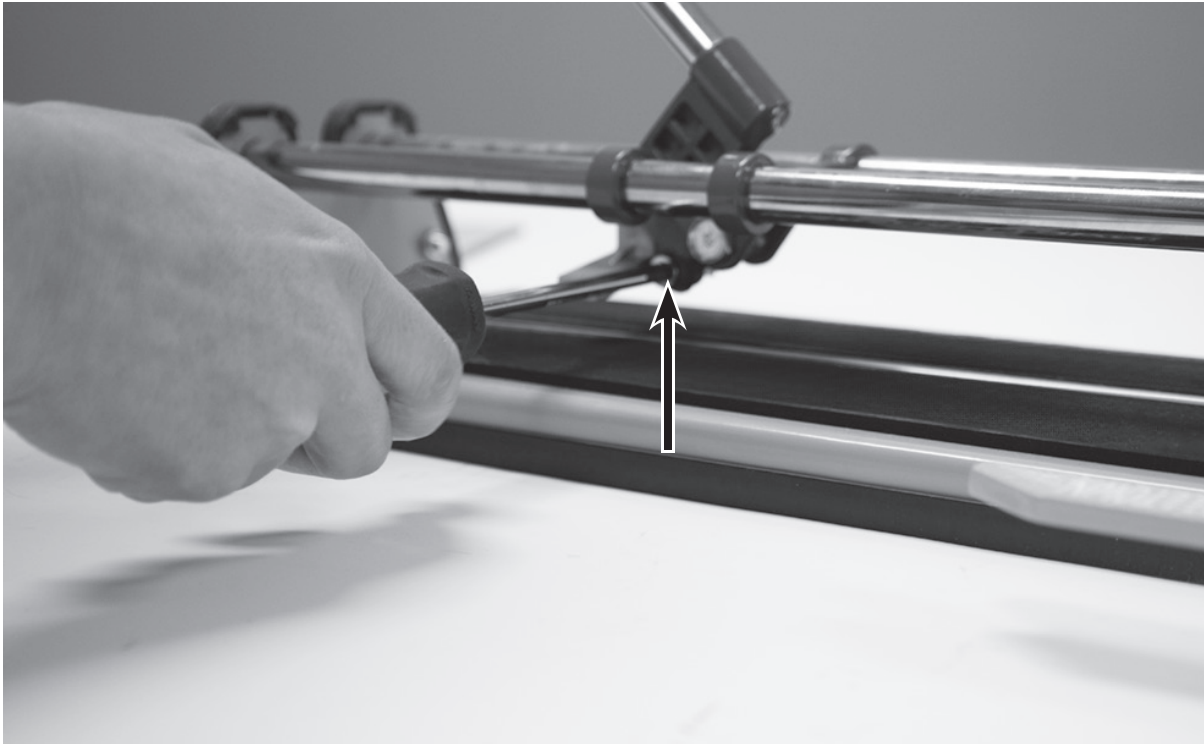

MAINTENANCE

The Tile Cutter requires little regular maintenance.

1. Clean the Tile Cutter after use by removing tile debris.
2. Lubricate the Guide Rods periodically.
3. Store and cover the Tile Cutter when not in use. Always store in a dry location.

REPLACEMENT PARTS

REF #	DESCRIPTION	PART#	Quantity
32476	SCORING WHEEL WITH FASTENERS	TC17SW	1
32477	GUIDE FENCE WITH THUMBSCREW	TC17GF	1
32478	BREAKER FOOT WITH FASTENERS	TC17BF	1

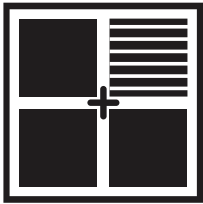

BARWALT®

A MARSHALLTOWN® BRAND

104 S. 8th Ave., Marshalltown, IA
Phone 800-888-0127 / 641-753-0127
Fax 800-477-6341 / 641-753-6341
www.MARSHALLTOWN.com
WS4089